

PORTABLE DVD PLAYER WITH 7" TFT LCD MONITOR

PDV-98



Instruction Manual



BEFORE USING THIS PRODUCT, READ, UNDERSTAND,
AND FOLLOW THESE INSTRUCTIONS.
Save this booklet for future reference.

CUSTOMER HELPLINE 0161 975 0458
WEB www.fascin8.co.uk

Safety information

CAUTION:

DVD/VIDEO CD/CD PLAYER IS A CLASS 1 LASER PRODUCT. HOWEVER THIS DVD/ VIDEO , CD/CD PLAYER USES A VISIBLE LASER BEAM WHICH COULD CAUSE HAZARDOUS RADIATION EXPOSURE IF DIRECTED. BE SURE TO OPERATE THE DVD/VIDEO CD/CD PLAYER CORRECTLY AS INSTRUCTED.

WHEN THIS DVD/VIDEO CD/CD PLAYER IS PLUGGED TO THE WALL OUTLET, DO NOT PLACE YOUR EYES CLOSE TO THE OPENING OF THE DISC TRAY AND OTHER OPENINGS TO LOOK INTO THE INSIDE OF THIS PLAYER.

USE OF CONTROLS OR ADJUSTMENTS OR PERFORMANCE OF PROCEDURES OTHER THAN THOSE SPECIFIED HEREIN MAY RESULT IN HAZARDOUS RADIATION EXPOSURE.

DO NOT OPEN COVERS AND REPAIR YOURSELF. REFER SERVICING TO QUALIFIED PERSONNEL

THIS DEVICE IS INTENDED FOR CONTINUOUS OPERATION!

TO REDUCE THE RISK OF FIRE OR ELECTRIC SHOCK, AND ANNOYING INTERFERENCE, USE THE RECOMMENDED ACCESSORIES ONLY.

WARNING:

- TO PREVENT FIRE OR SHOCK HAZARD. DO NOT USE THIS PLUG WITH AN EXTENSION CORD, RECEPTACLE OR OTHER OUTLET UNLESS THE BLADES CAN BE FULLY INSERTED TO PREVENT BLADE EXPOSURE.
- TO PREVENT FIRE OR SHOCK HAZARD. DO NOT EXPOSE THIS APPLIANCE TO RAIN OR MOISTURE.

CAUTION - LASER RADIATION WHEN OPEN, DO NOT STARE INTO BEAM.

VENTILATION WARNING - THE NORMAL VENTILATION OF THE PRODUCT SHALL NOT BE IMPEDED FOR INTENDED USE.



The lightning flash and arrow head within the triangle is a warning sign alerting you of "dangerous voltage" inside the product.

CAUTION
RISK OF ELECTRIC SHOCK
DO NOT OPEN

CAUTION: TO REDUCE THE RISK OF ELECTRIC SHOCK. DO NOT REMOVE COVER (OR BACK). NO USER SERVICEABLE PARTS INSIDE. REFER SERVICING TO QUALIFIED SERVICE PERSONNEL.



The exclamation point within the triangle is a warning sign alerting you of important instructions accompanying the product.

Always follow basic safety precautions when using electrical products, especially when children are present.

WARNING: To avoid the risk of electrical shock, make sure the product is unplugged from the electrical outlet before relocating, servicing, or cleaning it.

If the surface is soiled

Wipe gently with a soft, damp (water only) cloth.

When wiping discs, always move the cloth from the centre hole toward the outside, which will not cause distortion. (If you wipe the discs using a circular motion, circular scratches are likely to occur, which will cause distortion.)

If the disc is brought from a cold to a warm environment moisture may form on the disc

Wipe this moisture off with a soft, dry, lint-free cloth before using the disc.

Improper disc storage

You can damage discs if you store them in the following places:

- Areas exposed to direct sunlight
- Humid or dusty areas
- Areas directly exposed to a heat outlet or heating appliance

Maintenance

- Wipe the player with a dry, soft cloth.
- If the surfaces are extremely dirty, wipe clean with a cloth which has been dipped in a weak soap-and-water solution and wrung out thoroughly, and then wipe again with a dry cloth.
- Never use alcohol, benzene, thinner, cleaning fluid or other chemicals. And do not use compressed air to remove dust

Read all instructions before using

- Do not use this product near water.
- Do not ceiling- or wall-mount the product.
- Install the product in accordance with the operating instructions.
- Do not set the product near heat sources, such as radiators, heat registers, stoves, or other apparatus (including amplifiers) that produce heat.
- Protect the power cord from being walked on or pinched, particularly at plugs, convenience receptacles, and the point where they exit the product.
- Do not use attachments not recommended or sold by the product manufacturer as a risk of fire, electrical shock, or serious personal injury may result.
- Unplug the product during lightning storms or when unused for long periods of time.
- Do not expose the product to dripping or splashing water. Do not place objects filled with liquid (e.g., vases) on the product.
- Do not place in or expose the product to direct sunlight, extreme heat, humid or dusty locations.
- Never operate this product if it has a damaged power cord or plug, is not working properly, has been dropped, damaged, or exposed to moisture, water, or other liquids. Do not attempt to examine or repair this product yourself; take the product to a service centre for inspection and repair.
- Keep magnetic objects such as speakers, at a distance from the player.

LASER SAFETY



This set employs an optical laser beam system in the CD mechanism designed with built-in safeguards. Do not attempt to disassemble. Exposure to this invisible laser light beam may be harmful to the human eye. This is a Class-1 laser product. Use of controls, adjustments or procedures other than those specified herein may result in hazardous laser light beam exposure. This compact disc player should not be adjusted or repaired by anyone except qualified service personnel. The laser mechanism in the set corresponds to the stylus (needle) of a record player. Although this product uses a laser pick-up lens, it is completely safe when operated according to directions.

NOTE: The manufacturer is not responsible for any radio or TV interference caused by unauthorized modifications. Such modifications could void the user's authority to operate the equipment.

- 1) Operate turning controls and switches as instructed in the manual.
- 2) Before turning on the power for the first time, make sure that the power cord is properly installed.
- 3) Store your discs in a cool area to avoid damage from heat.

Battery Handling and Usage

NOTE: This style player contains rechargeable battery box. There is a CR 2025 battery for remote control.

- 1). Never throw batteries into a fire. Do not expose batteries to fire or other heat sources.
- 2). Battery Disposal: Spent or discharged batteries must be properly disposed of and recycled in compliance with all applicable laws. For detailed information, contact your local solid waste authority.

Table of contents

Getting Started:

Safety information	1-3
Features	4
Accessories	4
Control reference guide	5-6
Basic connection	7-9
Remote control preparation	10

Basic Operation:

Basic play	11
Stopping play	12
Skipping ahead or back	12
Fast forward or backward	12
Pause or play	12
Slow-motion play [DVD/VCD]	13
MP3 playback	13
JPEG CD	14
Enjoying Video CD with playback control	15-16
On screen display information	16

Advanced Operation:

Program play	17
Repeat play	17
Repeat viewing	18
A-B repeat play	18
TFT MODE	18
GO To	18
Changing subtitle language(DVD only)	18
ZOOM	19
Changing audio soundtrack language[DVD/VCD disc]	19
Viewing from different angle(DVD only)	19

Initial Settings:

General setup	20
Audio setup	20-21
Password setup	21

For Reference:

Definition of terms	22
Specifications	23
Troubleshooting	24
DISC handling and maintenance	24-25

Troubleshooting (Continued)

Symptom(Common)	Remedy
No operations can be performed with the remote control unit.	<ul style="list-style-type: none"> Check the batteries are installed with the correct polarities(+and -) The batteries are exhausted: replace them with new ones. Point remote control at the remote control sensor and operate. Operate the remote control unit at a distance of not more than 6 m from the remote control sensor. Remove the obstacles between the remote control and remote control sensor.
No key operation (by the main unit and/or the remote control unit) is effective.	Disconnect the power adaptor and then reconnect it. (The player may not be operating properly due to lightning, static electricity or some other external factor.)
Symptom [DVD]	Remedy
Play does not start even when title is selected.	Confirm the region code setting is right.
Audio soundtrack and/or subtitle language is not the initial settings.	If the audio soundtrack and/or subtitle language does not exist on the disc, the language selected at the initial settings will not be seen/heard.
No subtitles.	<ul style="list-style-type: none"> Subtitles appear only with discs which contain them. Subtitles are cleared from the TV monitor, Perform the steps display the subtitles.
Alternative audio soundtrack (or subtitle) languages fail to be selected.	<ul style="list-style-type: none"> An alternative language is not selected with discs which do not contain more than one language. In the case of some discs, the alternative language cannot be selected by operating the LANGUAGE or SUBTITLE button. Try selecting it from the DVD menu if one is available.
Angle cannot be changed.	This function is dependent on software availability. Even if a disc has a number of angles recorded, these angles may be recorded for specific scenes only.
The password for rating level has been forgotten.	Please contact your local sales dealer.
Symptom [Video CD]	Remedy
No menu play.	This function works only for Video CDs with playback control.

DISC handling and maintenance

Handling precautions

- Hold the disc by the edges so the surface will not be soiled with fingerprints. Fingerprints, dirt and scratches can cause skipping and distortion.
- Do not write on the label side with a ball-point pen or other writing utensils.
- Do not use record cleaning sprays, benzine, thinner, static electricity prevention liquids.
- Be careful not to drop or bend the disc.
- Do not install more than 1 disc on the disc compartment.
- Do not try to close the disc cover when the disc is not installed properly.
- Be sure to store the disc in its exclusive case when not in use.

Specifications

Power requirements:

AC 100 -240V~ 50/60Hz

Power consumption: 18W

Signal system: NTSC/PAL

Resolution: 480X3 (RGB) X 234

Dots Distance: 0.107 (W) X 0.370 (H) mm

Visible Range: 154.08 (W) X 86.58 (H) mm

Discs played:

(1) DVD-VIDEO disc

- 12 cm single-sided, single-layer
- 12 cm single-sided, dual-layer
- 12 cm double-sided, single-layer

8 cm single-sided, single-layer

8 cm single-sided, dual-layer

8 cm double-sided, single-layer

(2) Compact disc (VIDEO CD)

12 cm disc

8 cm disc

Video output level: 1 V_{pp}

Audio output level: 1.2V

Earphone output level:

(1KHz, 0dB, 25mW)

Pickup: Wave length: 655nm

Laser power: CLASS-1

Measurement: 200(L) X 156(W) X 38(D)mm

Weight: Approx. 660g

Specifications are subject to change without notice.

Troubleshooting

Before requesting service for this player, check the chart below for a possible cause of the problem you are experiencing. Some simple checks or an adjustment on your part may eliminate the problem and restore proper operation.

Symptom (Common)	Remedy
No power.	Insert the AC adaptor securely into the power outlet.
<ul style="list-style-type: none"> ● Play fails to start even when PLAY is pressed. ● Play starts but then stops immediately. 	<ul style="list-style-type: none"> ● Condensation has formed: wait about 1 to 2 hours to allow the player to dry out. ● This player cannot play a disc other than DVD, VCD and CD. ● The disc may be dirty and may require cleaning. ● Ensure that the disc is installed with the label side up.
No picture.	Ensure that the equipment is connected properly.
<ul style="list-style-type: none"> ● No sound. ● Distorted sound. 	<ul style="list-style-type: none"> ● Ensure that the equipment is connected properly. ● Ensure that the input setting for the TV and stereo system are correct. ● Adjust the master volume to a suitable volume by rotating the volume knob (22) at the side of the player.
Picture is distorted during rapid advance or rapid reverse.	The picture will be somewhat distorted at times: this is normal.
No rapid advance or rapid reverse play	Some discs may have sections which prohibit rapid advance (or rapid reverse.)

—To be continued

Features

7" TFT DISPLAY

This player has a built in 7" TFT display window, to provide clear vision, and low radiation.

ENCLOSED LITHIUM BATTERY PACK

This 12V rechargeable battery pack can last about 2 hours.

MULTI TV SYSTEM SUPPORT

The player can play discs with signal system of PAL and NTSC.

GRAPHICAL USER INTERFACE SCREEN

Simply by pressing the DISPLAY button on the remote control unit, information on the player and disc can be displayed on the TV screen for easy identification. The player's operations and settings can be performed by operating the remote control while monitoring screen.

MULTI-AUDIO FUNCTION

The audio soundtrack can be heard in up to 8 languages. (The number of audio sound languages depends on the software.)

MULTI-SUBTITLES FUNCTION

Subtitles may be displayed in one of a maximum of 32 languages depending on the software.

MULTI-ANGLE FUNCTION

This function allows you to choose the viewing angle of scenes which were shot from a number of different angles. (Limited to DVD recorded with multiple camera angles.)

PARENTAL LOCK FUNCTION

This prevents play unsuitable for children.

DISC FORMATS SUPPORTED BY PLAYER

The player can play back discs bearing any of the following marks:



Accessories

Remote control (Battery compartment Included)	1
Instruction manual	1
Battery box.....	1
AC adaptor	1
Audio/Video cable	1
Cigarette lighter.....	1
Earphone.....	1
Headrest carrying bag.....	1

Control reference guide

Main unit

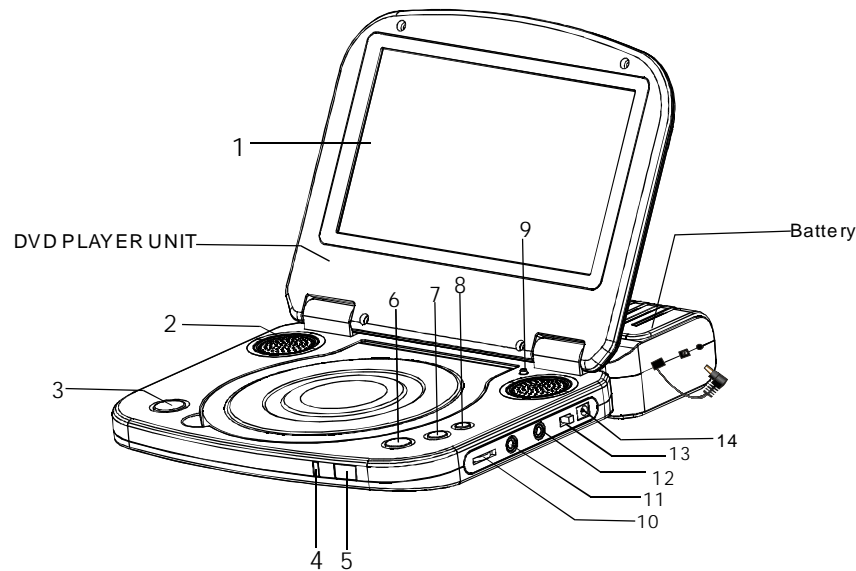

- 1 TFT Display window** - Displays all information about DVD work scene.
- 2 Built-in Speaker.**
- 3 OPEN button** - Press this button to open the disc cover.
- 4 Power indicator** - It is green when the unit is on
- 5 IR-Romote control sensor.**
- 6 PLAY button** - Press this button to start playing the disc.
- 7 PAUSE button** - Press this button to pause playing disc.
- 8 STOP button** - Press this button to stop playing.

- 9 SCREEN OFF button** - If you want to listen to sound only you can close the top cover. Then the screen gets black to be in saving power mode.
- 10 Volume** - Rotate this knob to adjust the volume to a suitable level.
- 11 Phone jack** - Connect headphone to this jack for listening.
- 12 AV Out jack** - Connect to TV or other external AV equipment to use the player as a signal source.
- 13 Power switch** - Switch this knob to turn on/off the player.
- 14 DC In jack** - Power input jack.

Definition of terms

DVD

This refers to a high-density optical disc on which high-quality pictures and sound have been obtained by means of digital signals. Incorporation a new video compression technology (MPEG II) and high-density recording technology, DVD enables aesthetically pleasing full-motion video to be recorded over long periods of time (for instance, a whole movie can be recorded). DVD has a structure consisting of two 0.6 mm thin discs which are adhered to each other. Since the thinner the disc, the higher the density at which the information can be recorded, a DVD disc has a greater capacity than a single 1.2 mm thick disc. Since the two thin discs are adhered to each other, there is the potential to achieve double-sided play sometime in the future for even longer duration play.

Video CD

This contains recordings of pictures and sound whose quality is on a par with that of video tape. This player also supports Video CDs with playback control (version 2.0).

MP3

These contain recordings of music which are compressed, allowing a significantly larger amount of music to be stored on a CD.

Angle

Recorded onto some DVD discs are scenes which have been simultaneously shot from a number of different angles (the same scene is shot from the front, from the left side, from the right side, etc.). With such discs, the ANGLE button can be used to view the scene from different angles.

Subtitles

This is the appearance of the dialogue at the bottom of the screen which are prerecorded on some DVD discs.

Title number

These numbers are recorded on DVD discs. When a disc contains two or more movies, these movies are numbered as title 1, title 2, etc.

Chapter number

These numbers are recorded on DVD discs. A title is sub-divided into many sections, each of which is numbered, and specific parts of video presentations can be searched quickly using these numbers.

Time number

This indicates the play time which has elapsed from the start of a disc or a title. It can be used to find a specific scene quickly. (It may not work with some discs.)

Playback control (PBC)

This is recorded on a Video CD (version 2.0). The scenes or information to be viewed (or listened to) can be selected interactively with the TV monitor by looking at the menu shown on the TV monitor.

Track number

These numbers are assigned to the tracks which are re-recorded on Video CDs and CDs. They enable specific tracks to be located quickly.

3.PASSWORD SET UP



3.1 PASSWORD - It is used to change the password, and the procedure of changing password is described as followings:

- Enter old password in the OLD PASSWORD row
- Enter new password in the NEW PASSWORD row
- Enter the new password again in the CONFIRM PWD row
- Press OK button on the screen to return to the Password Setup Page, then the Password has been changed.

NOTE: The original password is 136900, you can change it, but you should write it down and keep it safe. If you forget the password, please use the original password:136900.

3.2 PARENTAL - This setting allows certain people to view certain discs, which may be especially useful to forbid children from viewing some unbecoming discs. When you have entered the Parental Control, the screen will display:

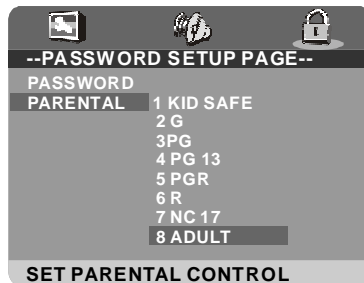

Scroll down the alternatives by moving Up or Down Navigation button, press ENTER button and enter the password which you has set before, then you have set a Parental Control. There are eight different settings from “Kid Safe” to “Adult” which you can choose.

Control reference guide

Remote control

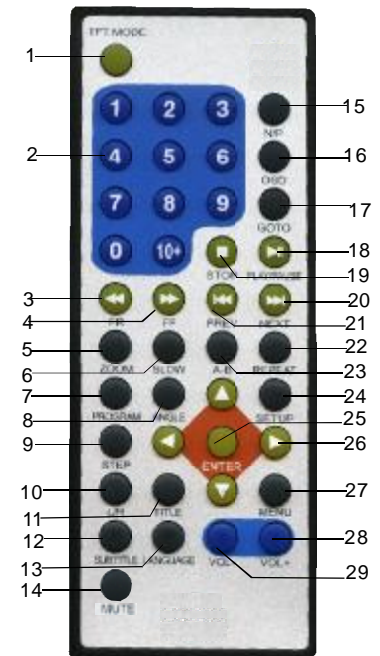

- 1 TFT MODE button**- Press this button to select BRIGHTNESS, CONTRAST, SHARPNESS, SATURATION, HUE or 16:9/4:3 screen mode and then press left or right button to adjust as you like.
- 2 NUMERIC buttons**- Press these buttons to input numeric information, such as track number, chapter number and so on.
- 3 FR button**- Press this button to play the disc backward at speeds: x2, x4, x8, x16, x32.
- 4 FF button**- Press this button to play the disc forward at speeds: x2, x4, x8, x16, x32.
- 5 ZOOM button**- Press this button to enlarge picture size, max. to X 4 or to shrink picture size, min. to X 1/4.
- 6 SLOW button**- Press this button to play the disc at speeds: 1/2, 1/4, 1/8, 1/16.
- 7 PROGRAM button**- Press this button to setup the memory order of chapter or title (for DVD) or tracks (for VCD/CD).
- 8 ANGLE button**- Press this button to display the angle number and change to different angles.
- 9 STEP button**- Press this button to play the file forward step by step.
- 10 L/R button**- To change audio output mode: Left Mono, Right Mono, Mix-mono and Stereo soundtrack.
- 11 TITLE button**- Press this button to return to title menu (for DVD).
- 12 SUBTITLE button**- Press this button to display and change subtitle language (For DVD only).
- 13 LANGUAGE BUTTON**- To select the soundtrack language (DVD).
- 14 MUTE button**- Press this button to mute the sound.
- 15 N/P button**- Press this button to select NTSC or PAL system (For DVD only).
- 16 OSD button**- Press OSD button continuously during playback, the screen will display the playing information, such as elapsed time, remaining time and so on.
- 17 GO TO button**- Press this button to set the player to play disc starting at a certain point.
- 18 PLAY/PAUSE button**- Press this button to start or pause playing the disc.
- 19 STOP button**- Press this button to halt playing.
- 20 NEXT button**- Press this button to play the next chapter (for DVD) or track (for VCD/CD).
- 21 PREV button**- Press this button to play the previous chapter (for DVD) or track (for VCD/CD).
- 22 REPEAT button**- Press this button to repeat playing one chapter or one title (for DVD) or repeat playing the current track or the whole tracks (for VCD/CD).
- 23 A-B button**- Press this button to repeat playing sections between two specific points (A-B).
- 24 SETUP button**- Press this button to enter initial settings menu.
- 25 ENTER button**- Press this button to confirm what you have selected.
- 26 navigation buttons**- Press this button to move up, down, left or right.
- 27 MENU button**- Press this button to return to the root menu (for DVD) or to turn on/off the PBC (for VCD).
- 28 VOLUME + button**- Press this button to turn up the volume.
- 29 VOLUME - button**- Press this button to turn down the volume.

Basic connection

- Ensure all the cables are disconnected from the main unit before connecting to AC power source by AC power adaptor.
- Read through the instructions before connecting other equipment.
- Do not charge up the battery pack while the DVD player is working with the battery pack.

Connecting to AC power source

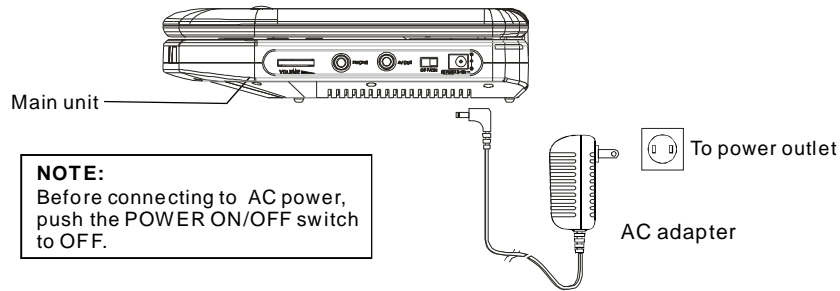

Connecting to battery pack

1. DC OUT plug
2. DC IN 12V jack to AC adaptor
3. Battery indicator

Connect the battery to the player as following:

1. Push the jag on the battery.
2. Insert the jags on battery pack into the apertures in the player.
3. connect the DC OUT plug on battery into DC IN jack in DVD.

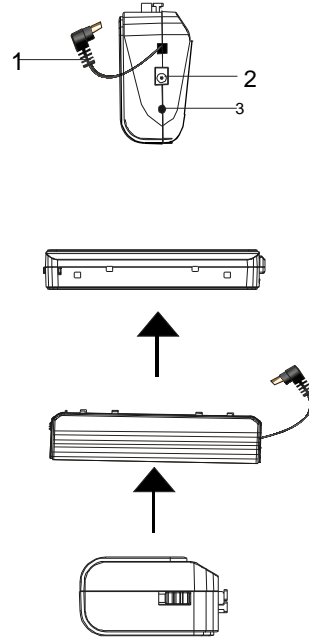

Charging the battery pack

Connect the adapter to the DC 12V IN jack on the battery for fully charged.

Time to recharge the battery

Recharge and playback time depends on battery pack capacity, and the temperature condition. Generally speaking, the time to charge is four hours about. If it is recharged during playing, the time to end recharge will be more. The battery indicator gets red during recharging, it gets green when the recharging end.

Time to playback

When the recharge finished, the battery can work solely for two hours about.

NOTE: A new battery pack which has not been used or one which has not been used for more than a month, it may appear to be not recharged enough, this is due to the characteristic of this battery and is not a malfunction. In this case, recharge it two or three times before the first use.

1.2 TV DISPLAY - it is for selecting TV output mode.

Options: Normal /PS: Pan & scan mode
Normal /LB: Letter box mode
Wide : 16:9 wide screen mode

1.3 ANGLE MARK - it is used to select whether or not the multi-angle icon is display on screen when a Multi-angle DVD disc is playing.

Options: On: Icon will be displayed
Off: Icon will be turned off

1.4 OSD LANG - It is used to choose the desired language for different user. In this player, you can choose English or other languages.

1.5 CAPTIONS - It is used to switch the caption ON/OFF when playing DVD disc.

1.6 SCREEN SAVER - when the player is not in use for 5 minutes, a running DVD logo will move across the screen to protect the TV CRT.

Options: On: Screen saver is enabled
Off: Screen saver is disabled

1.7 DEFAULT - It is used to reset to factory settings.

2. AUDIO SETUP

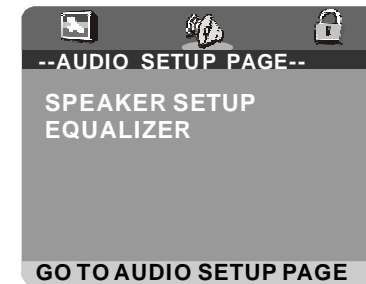

2.1 SPEAKER SETUP - it is used to set the speaker Output levels

Options: LT/RT-Left/Right mix mode
STEREO - Select this option if you don't Have a 2.1 channel amplifier.
SURROUND- It is used to set dummy surrounding audio effectiveness.

2.2 EQUALIZER SETUP - It is used to compensate for frequency distortion to improve its frequency response in audio systems(not applicable).

Options: SOUND MODE-It is for selecting the Equalizer Type, in this unit, you can choose Mono, Rock, Pop, Live, Dance, Techno, Classic or Soft.
BASS BOOST- It is used to turn the Bass Boost ON or OFF.
SUPER BASS- It is used to turn the Super Bass ON or OFF.
TREBLE BOOST- It is used to turn the Treble Boost ON or OFF.

Viewing from different angle (DVD only)

Some DVDs may contain scenes which have been shot simultaneously from a number of different angles. For these discs, the same scene can be viewed from each of these different angles using the ANGLE button. Press ANGLE during play, number of angle being played will be displayed in the screen, press the button to change to different angles.

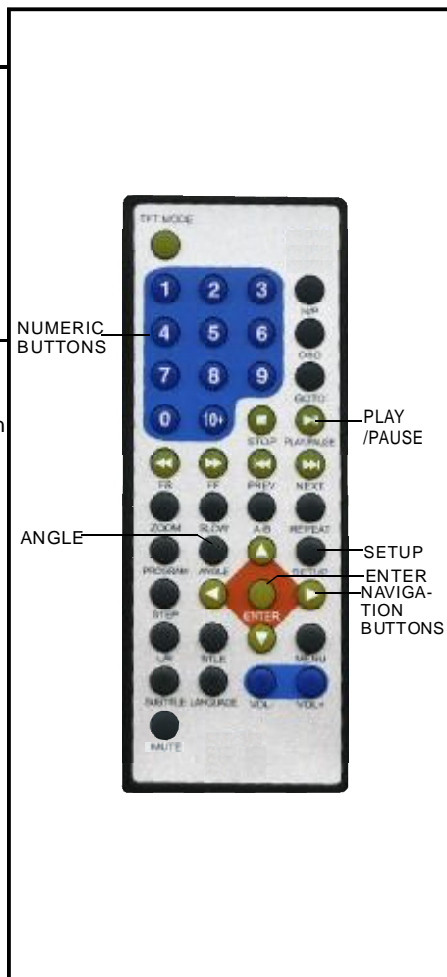

Initial Settings

Once the initial programming is entered it is retained in memory until changed, the player can always be operated under the same conditions.

Common procedure for initial settings

1. Press SETUP button.
2. Use the navigation buttons to select preferred item, and press ENTER button, each screen for setting the value is displayed. Then move the navigation button to set the item and press ENTER button to confirm the settings.
3. Press SETUP button to close setup menu in any mode.
4. Use left navigation button to switch to another main setup items

1. GENERAL SET UP

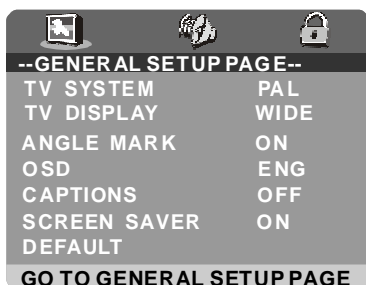

1.1 TV SYSTEM - it is for selecting the TV system according to the colour system of the TV.

Options :PAL
NTSC

Noises may be generated during recharging . In this case, use a more distant power socket. Do not recharge or discharge battery near a heating element such as a heater or direct sunlight Make sure that all the power source is disconnected before install.

-It is recommended to connect a multi-system TV.

-Do not block ventilation holes of equipment and arrange them so that air can circulate freely.

-Read through the instructions before connecting other equipment.

-Ensure that you observe the color coding when connecting audio and video cables.

Note:

- During DVD play, the TV volume may be at a lower level than during TV broadcasts, etc.
- If this is the case, adjust the volume to the desired level.
- If the DVD/VCD/CD player is connected to the TV through a video cassette recorder, the picture may not be played back normally with some DVDs. If this is the case, do not connect the player via the VCR.

Connecting to TV set

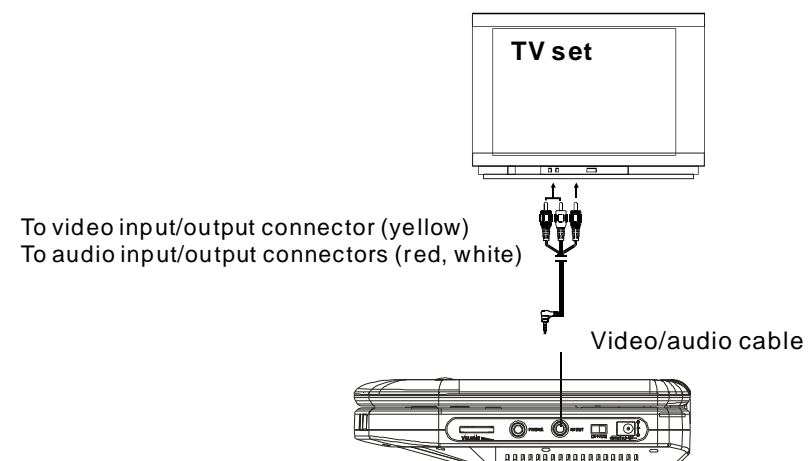

Basic connection

Connecting to audio equipment

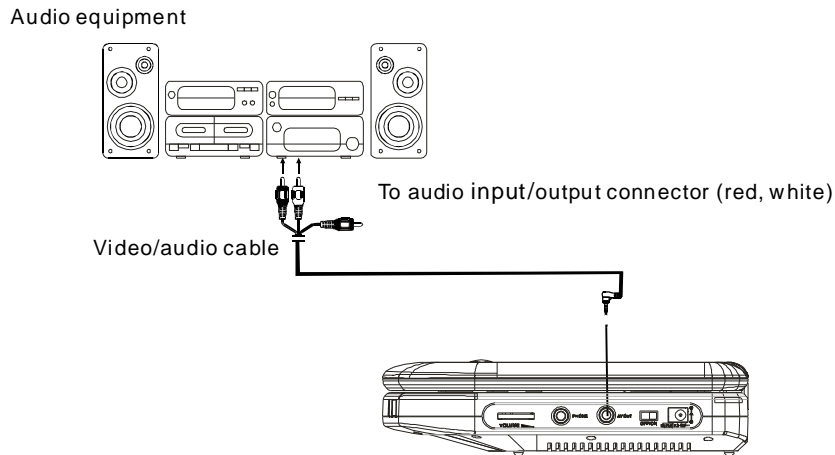

Connect headphones

- 1. Connect the headphones.**
Adjust the volume to minimize the volume.
Connect the headphones to phone jacks.
- 2. Adjust the volume to the level that you want.**

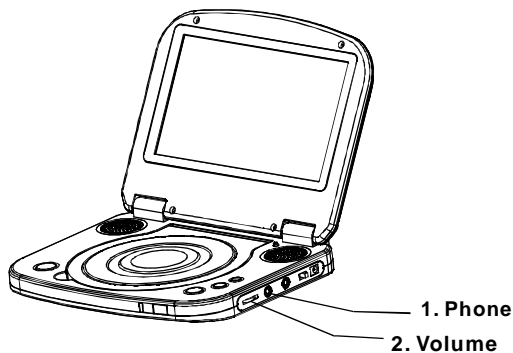

Changing subtitle language (DVD only)

It is possible to change the subtitle language to a different language from the one selected at the initial settings. (This operation works only with discs on which multiple subtitle languages are recorded)

1. Press SUBTITLE button during play, the screen will display the current language.
2. Press SUBTITLE button again to change language or turn off.

NOTE: When no subtitles are recorded, press this button will not work.

CHANGING SUBTITLE LANGUAGE

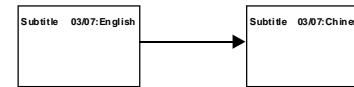

ZOOM PLAY

This function allows you to enjoy a motion picture.

- Press ZOOM button when playing, the screen shows:

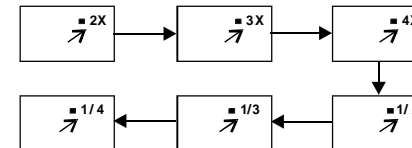

- Press NAVIGATION button to scroll across the enlarged picture.

Changing audio soundtrack language (DVD/VCD/CD disc)

It is possible to change the audio soundtrack language to a different language from the one selected at the initial settings (This operation works only with discs on which multiple audio soundtrack languages are recorded).

- Press LANGUAGE button while playing DVD disc, the screen will display the number of current soundtrack languages, pressing the button again will change the language.
- Pressing L/R button while playing VCD/CD disc will change audio output mode: Mono Left, Mono Right, Mix-mono and Stereo soundtrack.

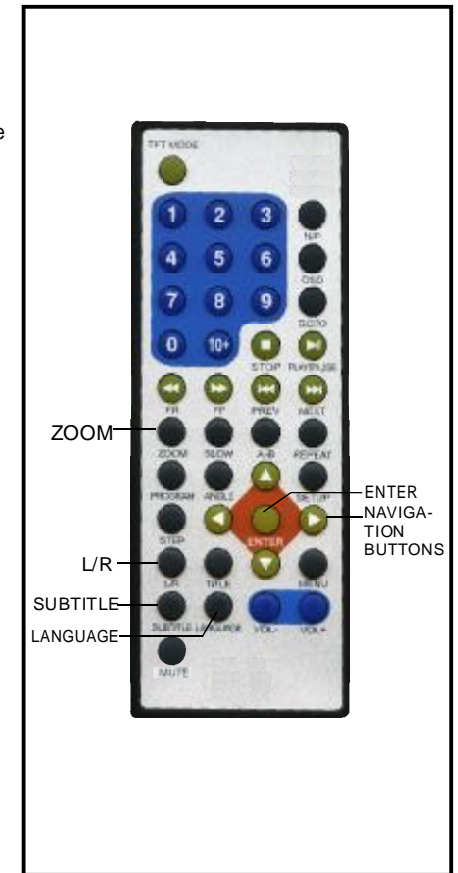

NOTE: When no soundtrack languages are recorded, pressing this button will not work. When the power is turned on or the disc is removed, the language heard is the one selected at the initial settings.



Repeat play

Press REPEAT button during play, it will repeat play one chapter or one title (for DVD disc), or repeat play track (for VCD/CD).

DVD DISC

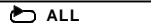
-  CHAPTER Repeat chapter
-  TITLE Repeat title
-  ALL Repeat all

VCD/CD DISC (In the PBC OFF mode)

-  TRACK Repeat track
-  ALL Repeat disc

A-B repeat play

Repeating sections between two specific points(A-B repeat)

1. Press A-B REPEAT button during play at the point where repeat play is to be started(A).
2. Press A-B REPEAT button at the point where repeat play is to be ended(B). Repeat play of the selection between points A and B starts.
3. Press A-B REPEAT button once again to return to normal play.

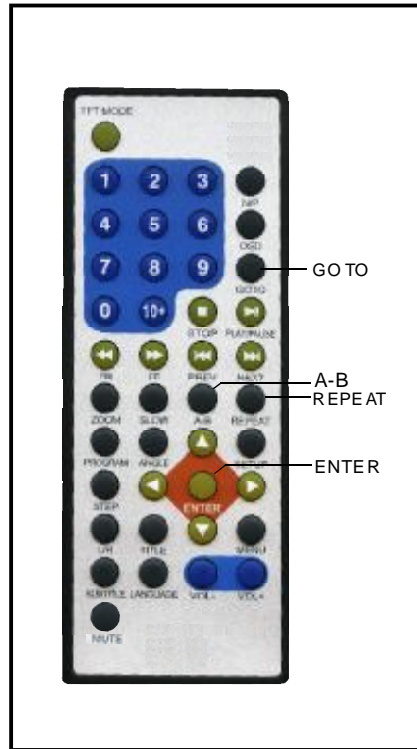

TFT MODE

Press TFT MODE button, the bottom at right of screen will display as the picture at right:

Press this button continuously to select BRIGHTNESS, CONTRAST, SHARPNESS, SATURATION, HUE or screen mode(16:9/4:3). Then press the LEFT or RIGHT navigation button to adjust the level of the selected item.

NOTE: The level of BRIGHTNESS, CONTRAST, SHARPNESS, SATURATION and HUE can be adjusted from -20 to +20. And the SCREEN MODE can be switched between 16:9 and 4:3. Press TFT MODE button again to exit the TFT MODE Menu Page.



GO TO

Press GO TO button, the screen will display a menu, then you can move Up or Down Navigation button and enter directly a time, chapter or track, the disc will play from the selected point. Press GO TO button again to exit the menu.

Remote control preparation

Battery installation

Insert the batteries while observing the correct (+) and (-) polarities as illustrated at right(Fig 1).

Service life of batteries

- The batteries normally last for about one year although this depends on how often, and for what operations, the remote control is used.
- If the remote control fails to work even when it is operated near the player, replace the batteries.
- Use one size CR2025 battery.

Note:

- Do not use rechargeable (Ni-Cd) batteries.
- Do not attempt to recharge, short-circuit, disassemble, heat or throw the batteries into the fire.
- Do not drop, step on or otherwise impact the remote control. This may damage the parts or lead to malfunction.
- If the remote control is not going to be used for a long time, remove the battery.

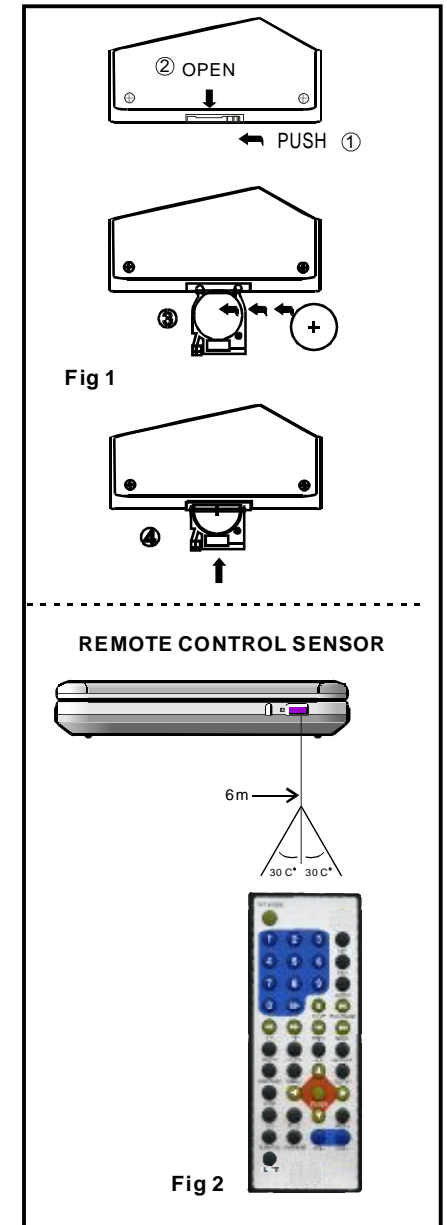

Remote control operation

1. Remove the protective plastic tab before operating the remote control (Fig 1).
2. Point the remote control from no more than about 6 m from the remote control sensor and within about 60° of the front of the player (Fig 3).

NOTE:

- The operating distance may vary according to the brightness of the room.
- Do not point bright lights at remote control sensor.
- Do not place objects between the remote control and the remote control sensor.
- Do not use this remote control while simultaneously operating the remote control of any other equipment.

Before enjoying DVD/Video CD/CD

The On-Screen menu language of your player has been factory pre-set to English.

If you want to change the menu language to other language, please refer to "Initial settings / General setup / OSD lang".

In the explanation below it is assumed that English has been selected as menu language.

Basic play

1. Switch on the power.

NOTE: 1). Make sure that all the connections including connections to AC adapter, other AV equipment etc. have been on the "ON" position. 2). After switch the power switch to the "OFF" position, if you want to switch it to the "ON" position again, you should wait at least 2 seconds, otherwise some deviant phenomena may appear, in this case, please turn the unit off then turn it on, it will work normally again.

2. Push the open button to open the disc cover.



3. Place a disc onto the disc compartment. Hold the disc without touching either of its surfaces, position it with the printed title side facing up, align it with the guides, and place it in its proper position.

4. Close the disc cover, after closing the disc cover, play begins. The player starts to read the disc immediately.

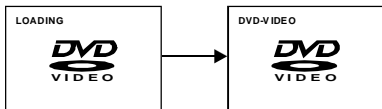

5. When a menu screen appears on the TV, move the navigation buttons or press the numeric buttons to select preferred track number, then press ENTER button to confirm.

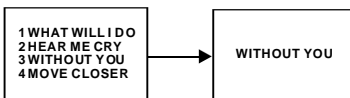

6. When the menu continues onto another screen, press NEXT button to view the next screen, or press PREV button to skip to previous screen.

NOTE: Due to the different design of some software titles, NEXT button may not always work.

7. To stop play and return to the menu screen, press TITLE button, or MENU button.

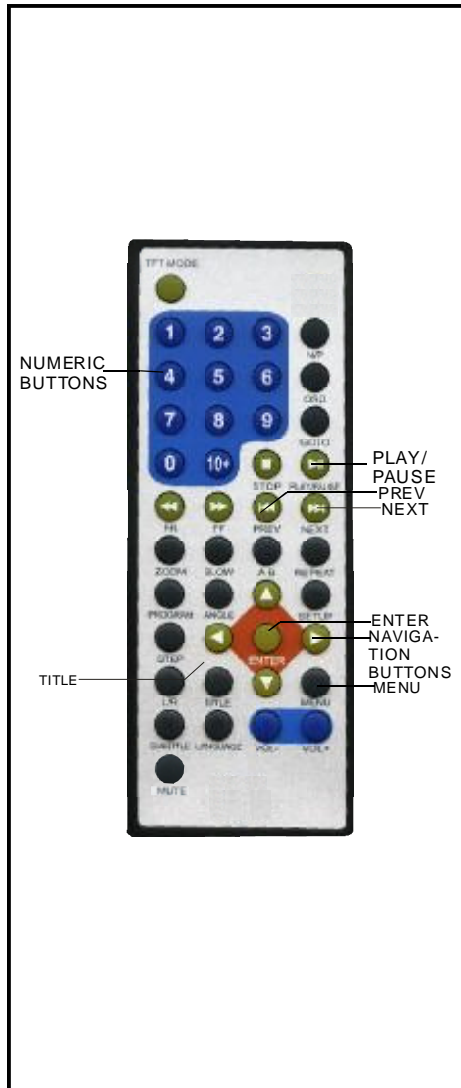

On screen display information

Press OSD button to display playing information.

DVD disc

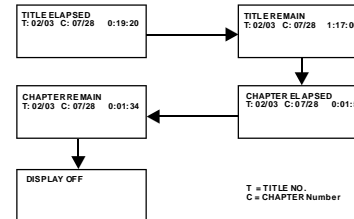

VCD disc



CD disc

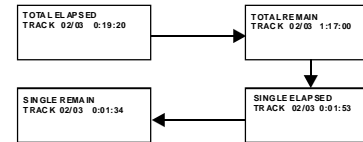

Program play

The player plays the tracks in an order you desired.

1. Press PROGRAM button and the screen will display the program menu.

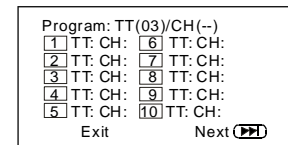

2. Press navigation buttons to choose memory index, then enter desired Titles/Chapters numbers by using the numeric buttons. The selected Titles/Chapters will be stored into the memory. Move navigation buttons to select NEXT on the menu and press ENTER button, then you can enter the next page, up to 20 memories can be stored.

NOTE: Leading zero is not necessary. If the track number is more than 10, press the 10 key first and then the unit digit.

Example: Track 3, press "3"

Track 12, press "10+" and then "2"

Track 21, press "10+" twice and then "1"

3. To start program play, move navigation buttons to select START on the menu, then press ENTER button.

4. To stop the program, press PROGRAM button and move navigation buttons to select STOP on the menu, then press ENTER button to confirm. After that, move navigation buttons to select EXIT on the menu and press ENTER button to exit the program menu.

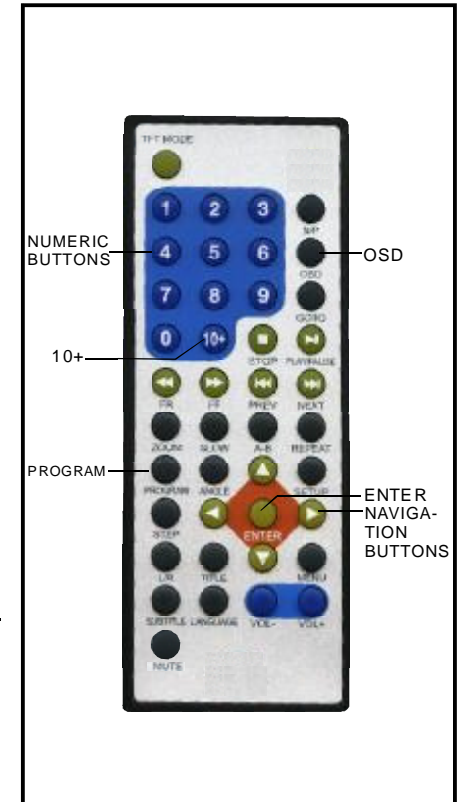

JPEG CD

Slide show effects

Press PROGRAM button to select one of the effects when changing from one picture to another:

- 1 WIPE TOP
- 2 WIPE BOTTOM
- 3 WIPE LEFT
- 4 WIPE RIGHT
- 5 DIAGONAL WIPE LEFT TOP
- 6 DIAGONAL WIPE RIGHT TOP
- 7 DIAGONAL WIPE LEFT BOTTOM
- 8 DIAGONAL WIPE RIGHT BOTTOM
- 9 EXTEND FROM CENTRE H
- 10 EXTEND FROM CENTRE V
- 11 COMPRESS TO CENTER H
- 12 COMPRESS TO CENTER V
- 13 WINDOW H
- 14 WINDOW V
- 15 WIPE FROM EDGE TO CENTRE
- 16 MOVE IN FROM TOP
- 17 NONE

Enjoying Video CD with playback control

1. When playing VCD 2.0 with PBC, the player will show the VCD version and PBC status on the screen.

VCD 2.0
PBC ON

2. After a few seconds, a menu will appear on the screen.

1 WHAT WILL I DO
2 HEAR ME CRY
3 WITHOUT YOU

3. Press numeric buttons to select corresponding track, if the track number is under 10, choose one of the numeric buttons 0 ~ 9. If the track number is exceed 10, press 10+ button firstly, then press numeric buttons 0 ~ 9.

4. Press NEXT or PREV button to play the next or previous track.

NOTE: When PBC is OFF, there will be no menu page on the screen, you can select any track to play by using numeric buttons. When PBC is ON, there will be a menu page on the screen, and you can select any track on the menu to play, however, when the selected track is being played, you can not change the play order any more except pressing the MENU button to return to the menu page again and select another track to play.

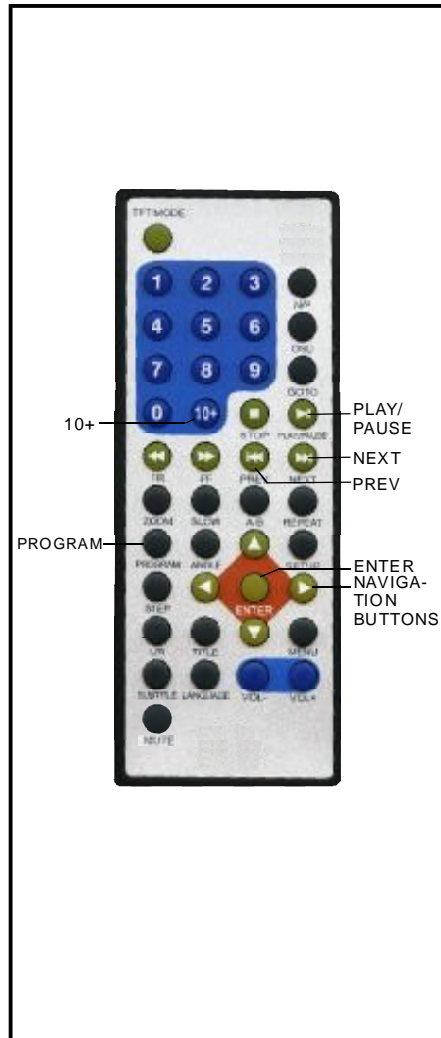

Stopping play

Press the STOP button to stop playing a disc.
NOTE: When player is stopped, the player records the point where STOP was pressed (RESUME function). Press PLAY again, playback will resume from this point. When the tray is Opened or STOP is pressed again, the RESUME function will be cleared.

Skipping ahead or back

Skipping ahead

Press NEXT button during play
A chapter (DVD) or a track (Video CD/CD) is skipped each time the button is pressed.

Skipping back

Press PREV button during play
A chapter (DVD) or a track (Video CD/CD) is skipped each time the button is pressed.

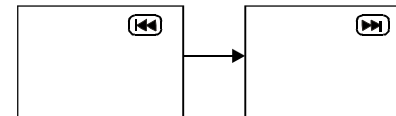

Fast forward or backward

During playback, press FF button or FR button to fast forward/rewind. Press PLAY/PAUSE button to resume normal play.

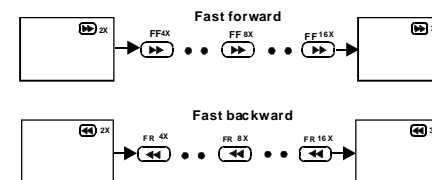

Pause or play

During playback, press PLAY/PAUSE button, the play will be paused, To resume normal play, press PLAY button.

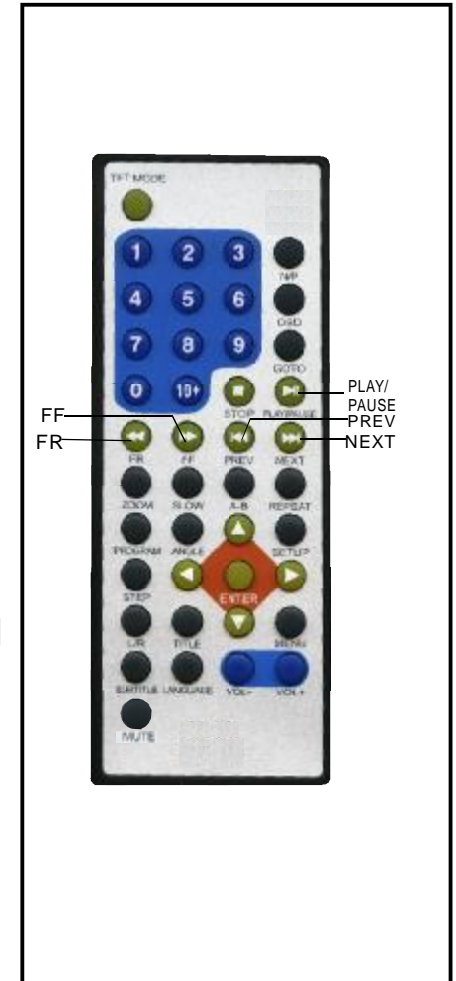
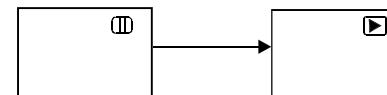

Slow-motion play (DVD/ VCD)

Press the SLOW button on the remote control during playback.

- 1) Plays the disc at a 1/2 of normal speed at first. Each time the button is pressed, the play Speed becomes 1/2, 1/4, 1/8, 1/16.
- 2) Press the PLAY/PAUSE button to resume to normal play.

MP3 playback

1. Insert the disc containing the files in Mp3 format to be played and after a few seconds, the screen of the monitor will show all the folders on the disc:

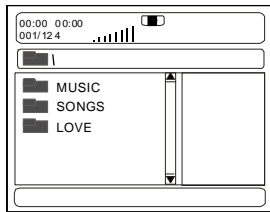

2. Select the folder you want to play by the navigation buttons and press the ENTER button to confirm.
3. The files in this folder are displayed and select the desired song by navigation buttons, then press the ENTER button to start playback.

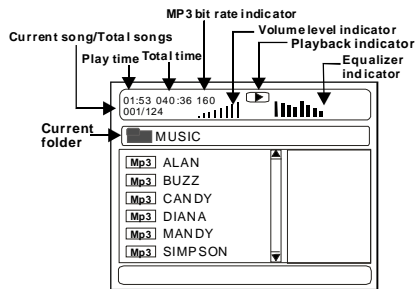

4. Press the PREV or NEXT button to turn the current menu page to the previous or next menu page.
5. Press REPEAT button to change play mode.
 - SHUFFLE: All the files will be randomly sorted and played by the order.
 - RANDOM: randomly select any file to play.
 - SINGLE: play one file only.
 - REPEAT ONE: repeat one file.
 - REPEAT FOLDER: all the files in the folder will be played repeatedly.
 - FOLDER: all the files in the folder will be played

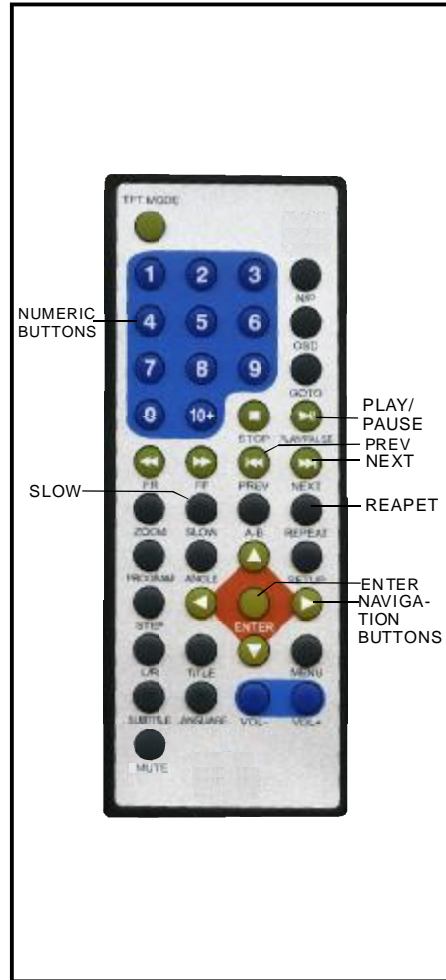

JPEG CD

- For JPEG picture CD, select the folder you want to play by the navigation buttons and press ENTER button to confirm.
- The files in this folder are displayed and select your pictures by using the up/down navigation buttons and press ENTER button to start playback. Thumbnail of picture will be displayed while you scrolling across the file name.



- Once a folder and file is selected, the picture is loaded onto the screen.



NOTE: The time to load and display picture depends on the file size of the pictures.

- During playback, press MENU button to return to folder selection or STOP button to enter preview mode.
- Press REPEAT button to change play mode
 - SHUFFLE: All the files will be randomly sorted and play by the order.
 - RANDOM: randomly select any file to play.
 - SINGLE: play one file only.
 - REPEAT ONE: repeat one file.
 - REPEAT ALL: All the files in the folder will be played repeatedly.
 - REPEAT OFF: No picture will be played repeatedly.

Skip to next/previous picture

Press NEXT button to skip to the next picture or PREV button to skip to the previous picture. If no key is pressed for 5 seconds, it will skip to next picture automatically.

Rotating pictures

- Press RIGHT navigation button to rotate the picture clockwise.
- Press LEFT navigation button to rotate the picture counter-clockwise.



Flipping pictures

- Press UP navigation button to flip the picture vertically.
- Press DOWN navigation button to flip the picture horizontally.



Picture Shrink/Zoom

- Press ZOOM button to enter the zoom mode
- Press FF button to enlarge picture to 100%, 125%, 150% and 200%
- Press FR button to shrink pictures to 100%, 75%, and 50%



If the picture is enlarged, you may press navigation buttons to see other portions of the picture.

